

Guide for Using the Equipment in CSE 167

Room Equipment: Document Camera; VHS/DVD player; ceiling projector; cabling to connect laptop computer
Doc Camera must be turned on to display images on the ceiling projector.

All equipment in this room is connected to the ceiling projector.

Location of Remote Controls : ceiling projector - on the Teaching Station; VHS/DVD - tethered to player

1. If using your laptop: Start with laptop turned off.

For computer image to be displayed, securely connect three (3) cables on top of teaching station to laptop labeled **1) LAPTOP Network** **2) LAPTOP Video** **3) LAPTOP Audio**

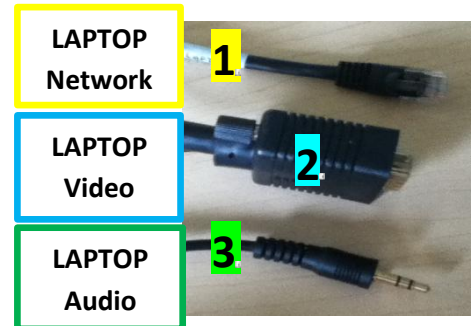

2. Turn on the Ceiling Projector

Ceiling projector remote is tethered to the top of the Teaching Station
 Wait for ON light to stop blinking. Lower screen.

3. Turn on your Laptop, log in, and wait as it communicates with the projector.

The computer image on the laptop will be displayed on the screen.

4. Press POWER button on the Document Camera. The Doc Camera controls all image displays.

Press and hold until it turns **Blue**.

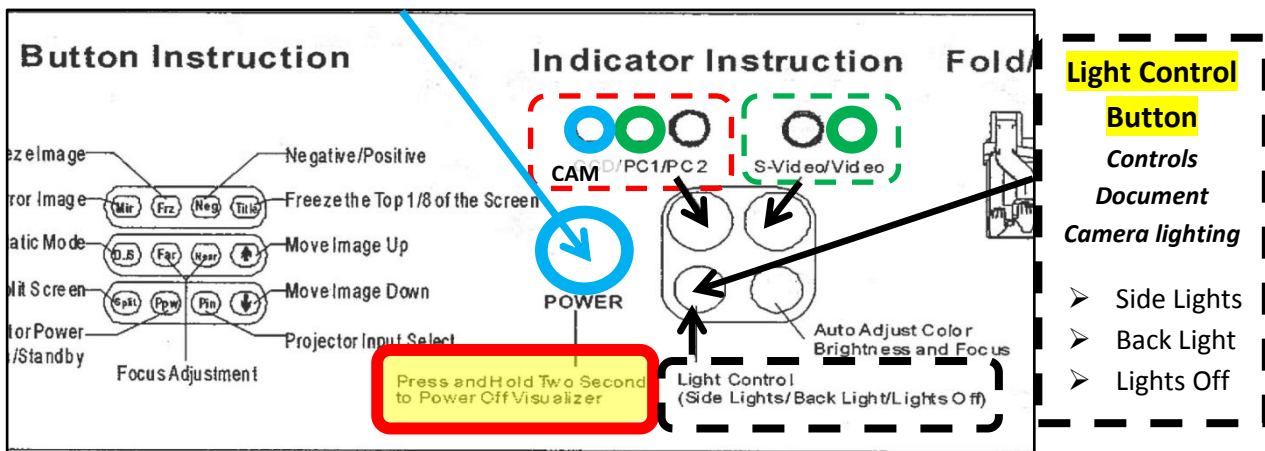

To display **Document Camera image** > Press the **button** labeled > **CAM /PC1/ PC2** displays **lighted blue circle** when selected (see graphic above)
Light Control Button will adjust lighting (see graphic above)

To display **Laptop image** > Press the **button** labeled > **CAM /PC1/ PC2** displays **lighted green circle** when selected (see graphic above)

Troubleshooting Tip: Press Fn + F4 or F8 (look for key with monitor icon) to toggle between laptop displays
 Windows 7 users, press WINDOWS key + P

To display **VHS/DVD image** > **Turn player on and load/play video.**

Press the **button** labeled > **S-VIDEO/VIDEO** displays **lighted green circle** when selected (see graphic above)

Button on center, front of VHS/DVD player controls video input; select VCR or DVD
 Remote for VHS/DVD is tethered alongside player

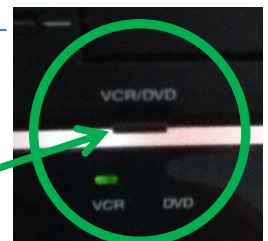

5. POWER OFF 1) Ceiling Projector 2) Document Camera 3) VHS/DVD Player 4) Laptop & disconnect cables
 Need assistance? Please contact Becki George, Learning Technology Coordinator, x.1268